

APPARTEMENT 2.34

2ème étage - Appartement n°34

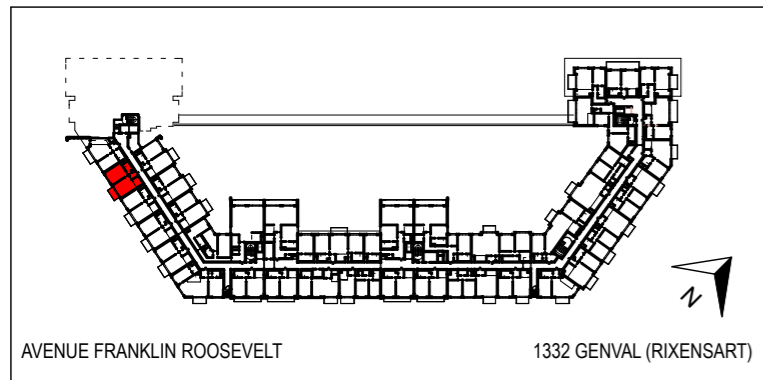

ATELIER D'ARCHITECTURE
DE GENVAL

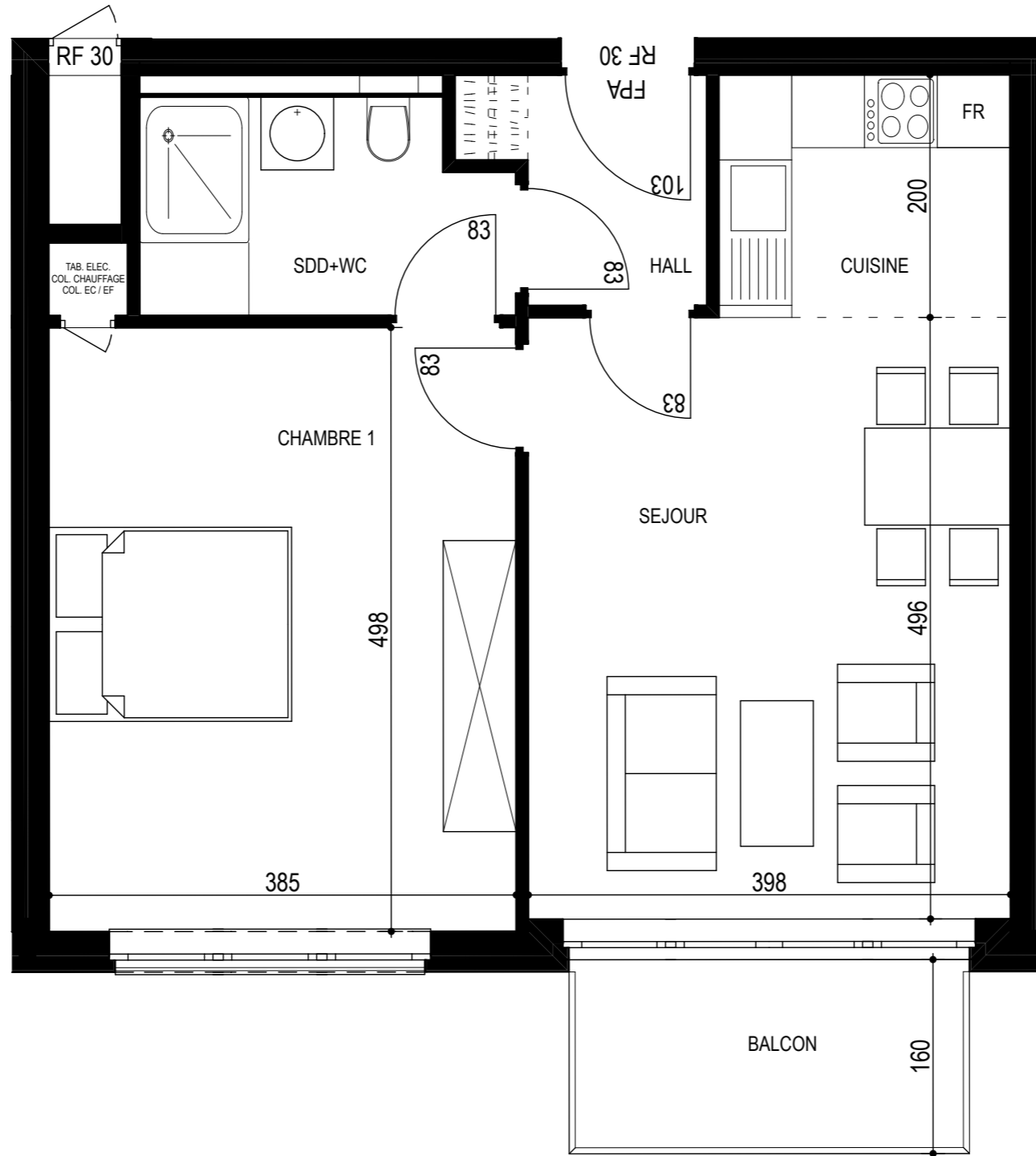

ECHELLE

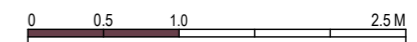

DATE

8/05/14

DOCUMENT A CARACTERE COMMERCIAL QUI NE CONSTITUE EN AUCUN CAS UN ENGAGEMENT CONTRACTUEL