

APPARTEMENT 2.31

2ème étage - Appartement n°31

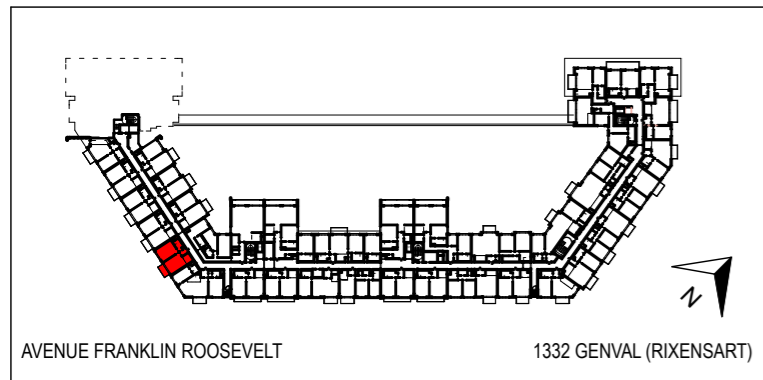

ATELIER D'ARCHITECTURE
DE GENVAL

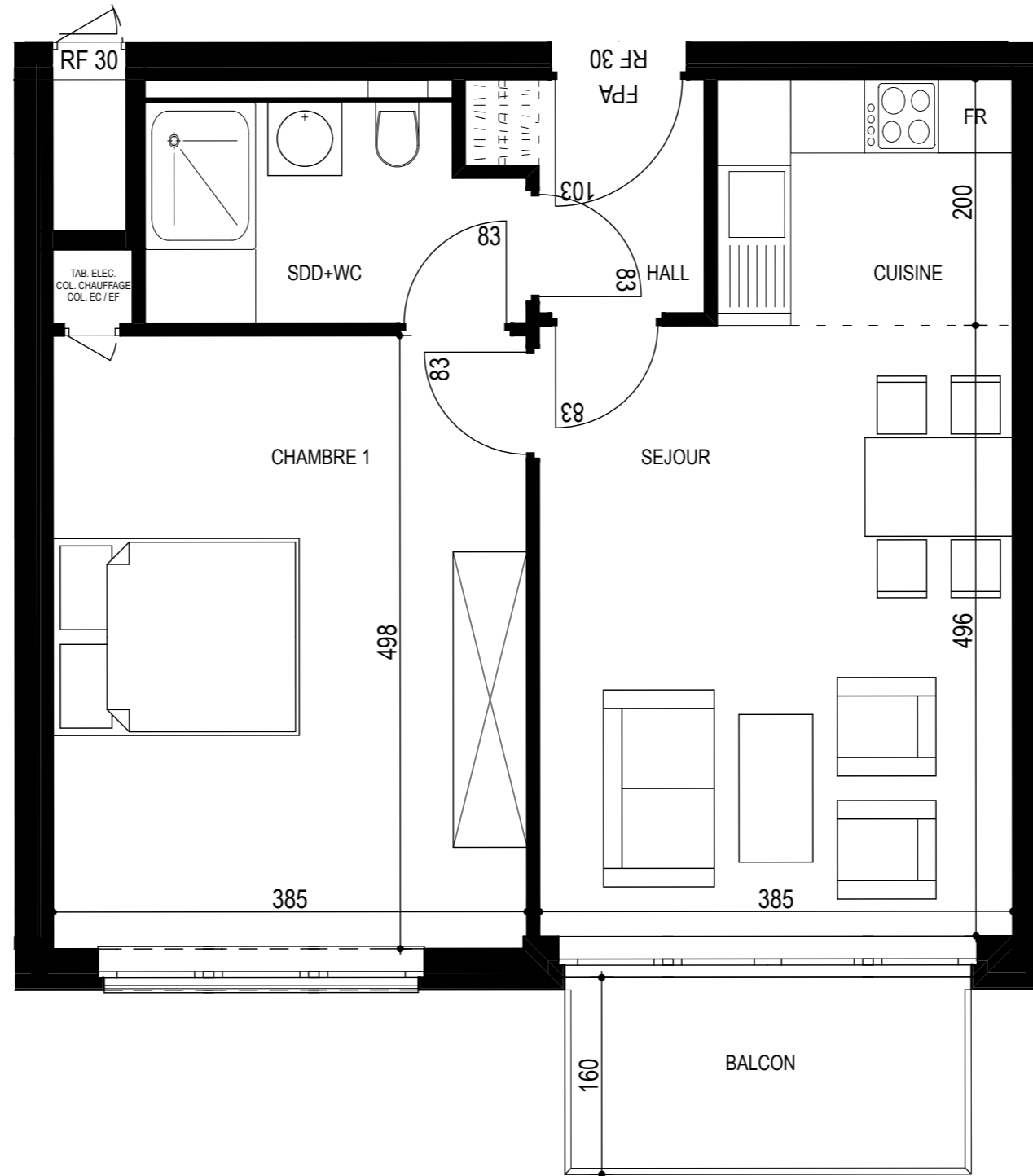

ECHELLE

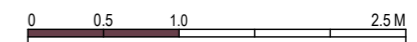

DATE

8/05/14

DOCUMENT A CARACTERE COMMERCIAL QUI NE CONSTITUE EN AUCUN
CAS UN ENGAGEMENT CONTRACTUEL